



AUTOMATIC VENT DAMPER

INSTALLATION INSTRUCTIONS AND TROUBLESHOOTING GUIDE

For Galaxy, Sentinel and Sentry Series Boilers

READ AND SAVE THESE INSTRUCTIONS
FOR REFERENCE.

The installation must conform to the requirements of the authority having jurisdiction or, in the absence of such requirements, to the National Fuel Gas Code, ANSI Z223.1-latest edition.

In addition, where required by the authority having jurisdiction, the installation must conform to American Society of Mechanical Engineers Safety Code for Controls and Safety Devices for Automatically Fired Boilers, No. CSD-1.

THIS MANUAL MUST BE LEFT WITH OWNER AND SHOULD BE HUNG ON OR ADJACENT TO THE BOILER FOR REFERENCE.



The vent damper shipped with your boiler may be a different model than illustrated above.

WARNING

By failing to follow the WARNING instructions listed below, a hazardous condition such as explosion, carbon monoxide poisoning, fire or all of these could result.

- This device is design certified by C.S.A. for use only on specific Slant/Fin Corporation gas boiler models. These boilers must also be equipped with a plate or rating plate which states that the boiler must* (may*) be used with a Slant/Fin Corp. automatic vent damper device and indicates the proper vent damper model or part number (See Table 1).
- * Boilers under 300,000 Btu/hr. input **MUST** use a vent damper. Note: GG-75 HES (Constant circulation), **MAY** use a vent damper. Boilers with 300,000 Btu/hr. input or greater equipped with IID (intermittent pilot ignition) **MAY** use a vent damper.
- This device must be installed and inspected annually by a qualified installer in accordance with the Slant/Fin vent damper installation instructions, Slant/Fin boiler installation instructions and the vent damper manufacturer's installation instructions included with this damper. If improperly installed, a hazardous condition such as explosion or carbon monoxide poisoning could result. If installed improperly, all vent damper and boiler warranties shall be voided.
- Use of this device on boilers other than those indicated above is **not** permitted.
- **CAUTION:** When servicing controls all wires must be labeled prior to disconnection. Wiring errors can cause improper and dangerous operation.
- This device must be installed on the outlet end of the draft hood of the boiler as close to the draft hood as practicable, and without modification of the draft hood (see figures 3 through 7).
- The inlet size of the vent damper must be the same nominal trade size as the outlet of the draft hood. See Table 1 for the boiler models and their corresponding vent damper models.
- The device must be located in a venting system or section of a venting system so that it serves only the single appliance for which it is installed.
- Clearances of not less than 6 inches (152 mm) must be maintained from combustible materials, with provisions for access.
- If the boiler will not fire, **DO NOT** jump any of the safety controls (the vent damper circuit is part of the safety control circuit). Check page 4 of this manual for troubleshooting guide.

INTRODUCTION

This product is an automatic, motorized stack damper that has been developed to increase the efficiency of heating systems by reducing standby losses from the heating apparatus and the conditioned air space. The damper closes the chimney vent when the burner is off and fully opens it when combustion is required. The concept is similar to the opening and closing of a fireplace flue, except that the operation is completely automatic. An interlock has been added which prevents burner operation unless the damper is in an open position. A closed damper substantially reduces standby losses on boilers.

DESCRIPTION

The unit must be installed after the appliance draft diverter and as close to it as practicable, without modification of the draft hood. When the damper is in the closed position, it will prevent residual heat in the heating appliance from being drawn up the chimney vent by its natural draft. If located within a heated area, a closed damper will also prevent conditioned air from being pulled through the draft diverter and up the chimney by the same stack effect.

When combustion is required, the damper will rotate to its open position BEFORE an integral end switch activates the burner circuit. If the damper does not rotate to its open position, the burner circuit will not be activated.

When the heating requirement has been satisfied, the burner will go off immediately, and the damper will rotate to its fully closed position.

Potential fuel savings can vary based on the following factors:

1. Geographical location of dwelling
2. The size of heating plant relative to heat loss of dwelling
3. Location of heating plant within dwelling
4. Diameter of venting system
5. Total height of chimney above heating plant
6. Outdoor temperatures over a given period of time
7. Sustained wind velocities over a given period of time
8. Settings of operating and limit controls on heating plant
9. Source of domestic hot water, temperature of water, and amount used
10. Room thermostat settings
11. Infiltration factors of dwelling
12. Number of heating zones
13. Day/night thermostats
14. Presence of other vents and exfiltration factors
15. Chimney vent friction

GENERAL INFORMATION

VENT SIZE	APPROX SHIP WT. (WITH HARNESS) IN LBS.
4"	3.5
5"	3.5
6"	4
7"	4.5
8"	5
9"	6
10"	7

ELECTRICAL Minimum Wiring Requirements

24VAC, 18 gauge, 90°C

Thermostat Anticipation

Flair 0.1 AMP + control circuit
Honeywell Inc. 0.2 AMP + control circuit
Johnson 0.2 AMP + control circuit
Field Controls (Effikal) 0.1 AMP + control circuit

FEATURES

100,000 trouble-free operations in life cycle test • Burner "OFF" before start of damper close • Normal burner operations with damper disabled open • No burner operation with damper disabled closed • External damper position indicator • Direct drive, no-linkage and switch for burner off/on cycle • Low voltage (24V) circuitry compatible with standing pilot and intermittent ignition devices • CSA retrofit certification ANSI Z21.66 - latest edition • "Free-wheeling" permits free rotation of vane during installation without motor damage • Both operator motor and operator control (P.C. board) are replaceable

INSTALLATION INSTRUCTIONS

I. Before you start to install

1. Read this installation manual, vent damper manufacturer's instructions, the "WARNING" label attached to the top of the boiler, the "WARNING" on the wiring diagram and the "DANGER" label on the vent damper carton.

2. Perform pre-installation inspection as required by ANSI specification Z21.66. See manufacturer's vent damper instructions.
3. Turn off all electrical power, gas supply and wait for system to cool (for previous installed boilers).
4. Select a proper, convenient location (see figures 3, 4, 6 and 7).
5. Carefully unpack the unit. **DO NOT FORCE IT OPEN OR CLOSED!** Forcing the damper may damage the gear train and void the warranty.

WARNING—DANGER

Once you have begun vent damper installation procedure, DO NOT restore electric power and gas supply until installation and inspection have been completed (in order to prevent the main burners from operating). DO NOT operate the boiler until the vent damper harness "RECEPTACLE B" is plugged into "MALE PLUG" (as described in the installation instructions), and the vent damper installation and check-out procedures have been completed. Failure to observe this warning may create a hazardous condition that could cause an explosion or carbon monoxide poisoning.

II. Now, proceed as follows for Boilers with input under 300,000 Btu/hr.:

1. Remove the front cover of the boiler (Galaxy models only) exposing the wiring compartment. With all electrical power to boiler off, locate "MALE PLUG". Refer to the wiring diagram attached to boiler. A copy of the wiring diagram may also be found in the boiler installation manual. To find the correct wiring diagram in installation manual, match the number found in the lower right hand corner of the boiler wiring diagram with the identical number on one of the diagrams in the manual.
2. This device must be installed on top of the draft hood or diverter in position as shown in figures 3, 4, 5, 6 and 7. The vent damper must be installed so that the damper position indicator is in a visible location after installation for position indicator description. The arrow imprint on the damper should point in direction of vent gas flow (towards chimney). Flue pipe (other than flue collector on boiler) insertion depth for the male end should not exceed one inch into the vent damper. Be sure the vent damper is well seated and fasten with 3 sheet metal screws. Screws should be no longer than 1/2 inch.
3. Be sure that **undersized vent pipe does not block movement of damper vane**
4. **NOTE:**
Galaxy 300,000 Btu/hr. Intermittent Pilot (IID) boilers 300,000 Btu/hr and larger **may** have a vent damper (see page 1). They are factory wired with "MALE PLUG" and "RECEPTACLE A". To install the vent damper, cut the RED wire connected between number 3 and 4 of "RECEPTACLE A" (the only wire connected to this receptacle) and then disconnect "RECEPTACLE A" from "MALE PLUG". Remove "RECEPTACLE A" from job site and discard. Boilers that **must** have a vent damper (boilers with input under 300,000 Btu/hr.) are factory wired with "MALE PLUG" only.
5. a) **Galaxy boilers:** Attach the flexible metallic conduit vent damper harness to the right hand side of the jacket by passing the free end ("RECEPTACLE B") of the harness through the 7/8" diameter hole in the top of the jacket, and using the BX connector at the free end of the metallic conduit, fasten to jacket. Connect "RECEPTACLE B" into "MALE PLUG" (see correct wiring diagram). Attach the other side of the vent damper harness to vent damper operator (if not attached) and connect Molex connector to operator receptacle. For more information, see Galaxy installation manual, GG-41.
b) **Sentry and Sentinel boilers:** All Slant/Fin Sentry and Sentinel boilers are supplied with vent damper. "MALE PLUG" and "RECEPTACLE B" are in control box. For vent damper installation instruction see Sentry installation manual, S-42 or Sentinel installation manual SE-42.
6. All Slant/Fin Corp. Galaxy **steam** boilers equipped with intermittent pilot ignition systems are factory wired except for the wires to the low water cut-off and pressure cut-off. Wire these controls with wire provided with boiler (see boiler wiring diagram on boiler). Then follow previous instructions shown in 4 and 5 above.
7. Follow instruction for electrical wiring in boiler installation manual (Galaxy, GG-41; Sentry, S-42 or Sentinel SE-42) or restore electrical power and turn on gas supply (for previously installed boilers). See wiring diagram attached to the boiler or in boiler installation manual.

III. After Installation

1. Operate system through two complete cycles to check for opening and closing in proper sequence, and proper burner operation. **Damper must be in open position when boiler main burners are operating.**
2. Perform installation checks as required by ANSI specification Z21.66. See manufacturer's vent damper instructions.
3. Replace the front cover of the boiler. (Galaxy models only.)
4. Check the troubleshooting section if problems arise with the installation.

For more information, see Slant/Fin boiler installation manual GG-41 for Galaxy, S-42 for Sentry, SE-42 for Sentinel, and the vent damper manufacturer's booklet shipped with the vent damper.

VENT DAMPER SUITABILITY

Check the rating plate attached to the boiler for proper vent damper part number to use on the boiler.

WARNING - IMPORTANT

Damper circuit is designed to be controlled by low voltage controls. **DO NOT** use line voltage operating controls to interrupt supply voltage to the L8148E, L8124E, aquastats and Hydrostat 3200 or system transformer on steam system.

CAUTION

Label all wires prior to disconnection when servicing control. Wiring errors can cause improper and dangerous operation. "Verify proper operation after servicing"

VENT DAMPER MODEL NUMBER

In Table 1, the proper Slant/Fin Corp. vent damper model numbers are shown adjacent to the specific Slant/Fin Corp. boilers with which these vent dampers may be used.

WARNING

OTHER VENT DAMPERS OR DEVICES WITH SIMILAR PURPOSE ARE NOT PERMITTED.

Table 1.

For Slant/Fin Boiler Model No.†	Vent Size Inches	Use Slant/Fin Vent Damper Part No.
S-34, S-60, SE-70	4	41-2704-040
GG-75H, GXH-105, GXHA-100, GXHA-120, S-90, SE-105, SE-140	5	41-2705-040
GG-100H, GG-125H, GG-150H, GG-175H, GXH-125, GXHA-160, S-120, SX-150, SE-175	6	41-2706-040
GG-200H, GG-225H, GXH-150, GXH-170, GXH-190, GXH-210, GXH-230, GXHA-200, GXH-250, GXH-275, S-150, SX-180, SX-210, SE-210, SE-245	7	41-2707-040
GX-225, GX-250, GG-250H, GG-275H, GG-300, GG-325, GXH-300	8	41-2708-040
GG-350, GG-350H, GG-375, GXH-300H	9	41-2709-040
GG-375H, GG-399H	10	41-2710-040

† May have suffix "E", "D", "P", "PZ", etc.

May be any 3 digits.

DIMENSIONS

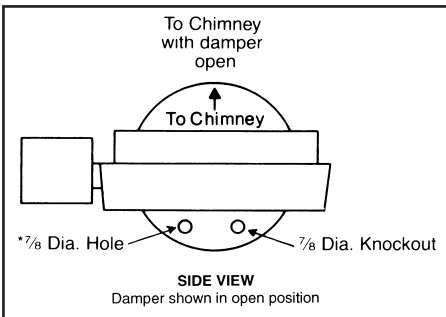

Figure 1.

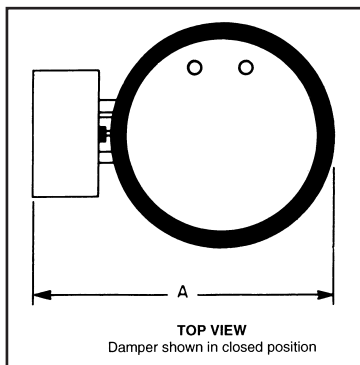

Figure 2.

Table 2.

Vent Size	4"	5"	6"	7"	8"	9"	10"
A	9 ⁵ / ₈ "	10 ⁵ / ₈ "	11 ⁵ / ₈ "	12 ⁵ / ₈ "	13 ⁵ / ₈ "	14 ⁵ / ₈ "	15 ⁵ / ₈ "

* May be plugged with plug provided, ONLY if boiler is equipped with an intermittent ignition pilot. For more information on specific vent dampers see manufacturer's manual included.

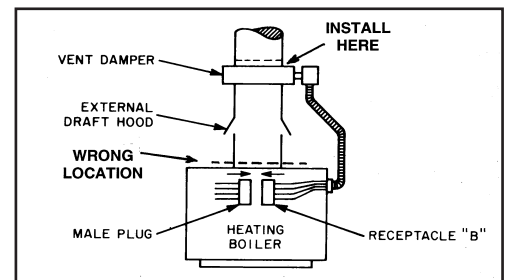

Figure 3. Vertical Installation

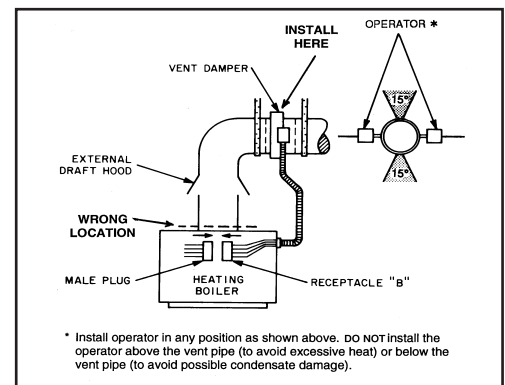

Figure 4. Horizontal or Sloping Installation

NOTE: READ MANUFACTURER'S INSTRUCTION MANUAL INCLUDED IN VENT DAMPER CARTON.

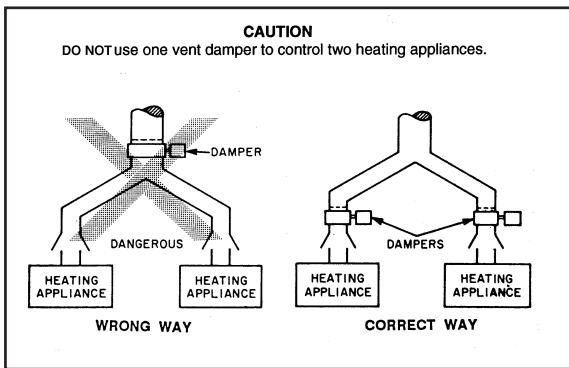

Figure 5.

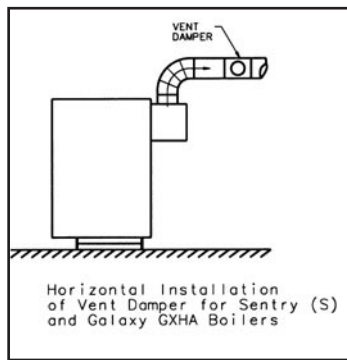

Figure 6.

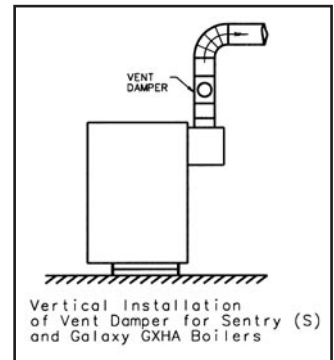

Figure 7.

TROUBLESHOOTING GUIDE

(listed in order of probability)

SYMPTOM	POSSIBLE CAUSE	REMEDY
Heating required and burner will not operate. Damper open.	Thermostat is set wrong.	Reset room thermostat to call for heat.
	No electrical power.	Turn on switch, replace fuse, reset circuit breaker, or repair wiring.
	Improper wiring.	Recheck and correct any wiring errors.
	Defective burner components.	Check, repair or replace burner components, gas valve, pilot, IID, IID sensor, etc.
	Damaged or defective damper operator.	Replace damper operator.
Burner operates normally. Burner shuts down normally, but damper will not close.	Damper is blocked open.	Check for free damper movement, and remove blockage.
	Improper wiring.	Recheck and correct any wiring errors.
	Damaged or defective damper operator.	Replace damper operator.
Burner will not operate. Damper closed and will not open.	No call for heat.	Reset thermostat (heat or hot water) to call for heating.
	Damper is blocked closed.	Check for free damper movement and remove blockage.
	Improper wiring.	Recheck and correct any wiring errors in line and low voltage circuits.
	Broken return spring (if equipped).	Replace drive assembly.
Burner will not operate. Damper operates normally.	Improper wiring.	Recheck and correct any wiring errors.
	Defective burner components.	Check, repair or replace burner components.
Burner operates before damper is open.	Improper wiring.	Recheck and correct any wiring errors.
Damper vane stops in other than fully open or fully closed position.	Damper is blocked.	Check for maximum 90° damper movement. If less than 90°, remove blockage.
	Missing roll pin damper stop.	Replace stainless steel roll pin.
	Broken coupling.	Inspect and replace drive assembly.
	Broken return spring (if equipped).	Replace drive assembly.
	Broken spring stop (if equipped).	Replace drive assembly.
Intermittent burner operation. (Damper operates normally.)	Burner access door open.	Re-install door and fasten with wing nuts.
	Bent or broken coupling.	Replace drive assembly.
	Bad ground.	Recheck and correct any wiring errors.
	Damaged or defective switch.	Replace damper operator.
Burner operates with damper closed.	Improper wiring.	Recheck and correct any wiring errors.

INSTALLATION AND SERVICE SHOULD BE PERFORMED BY A QUALIFIED INSTALLING OR SERVICE AGENCY.



SLANT/FIN CORPORATION, Greenvale, N.Y. 11548 • Phone: (516) 484-2600
FAX: (516) 484-0933 • Canada: Slant/Fin LTD/LTEE, Mississauga, Ontario

www.slantfin.com